



一级代理商：

深圳市弗瑞鑫电子有限公司

地址：深圳市宝安区西乡大道302号金源商务大厦B座三楼

frxelec

- (1)
- (2)
- (3)
- (4)
- (5)
- (6)
- (7)
- (8)



(1)

(2)

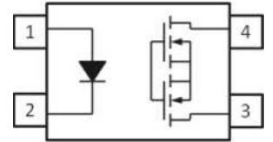

Pin Configuration
 1. Anode
 2. Cathode
 3. 4. MOSFET



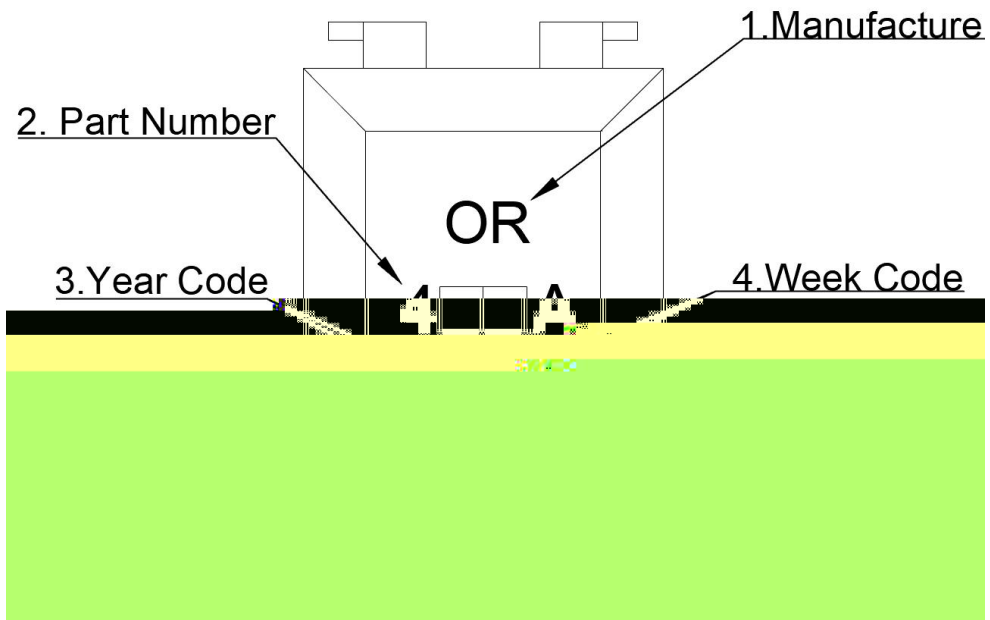

:

:

:)

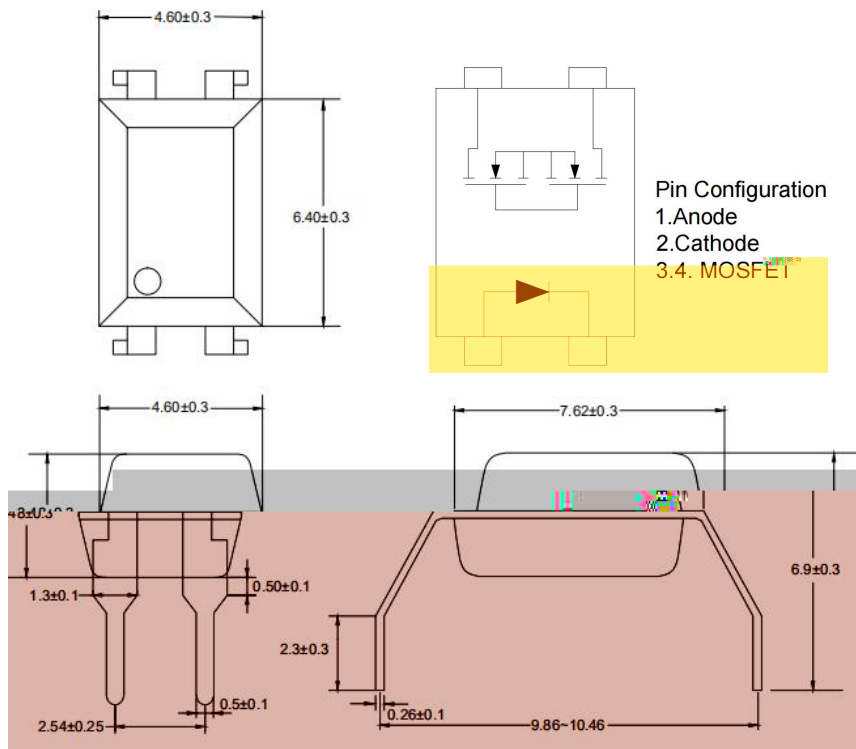
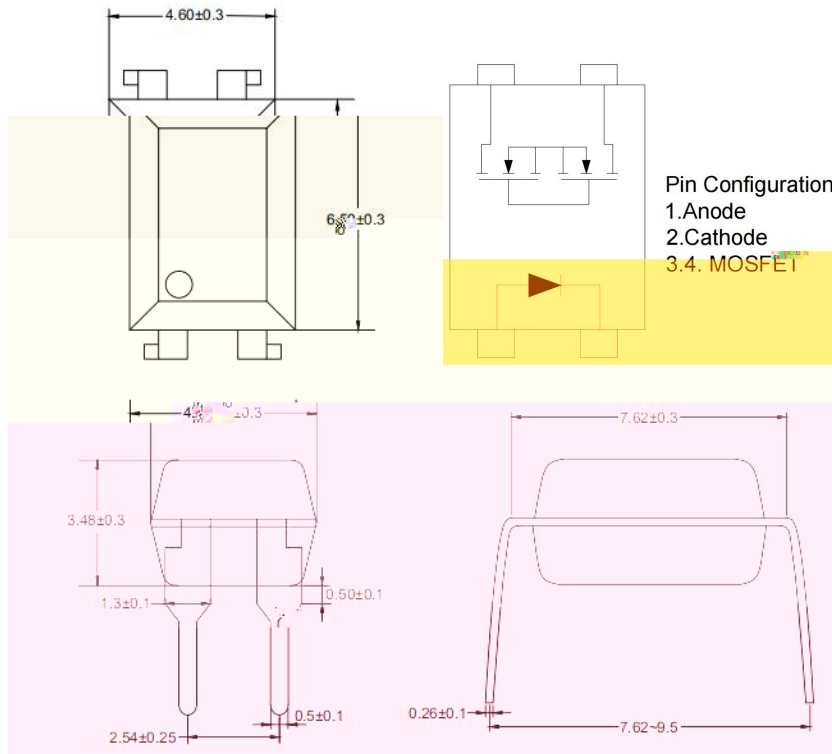

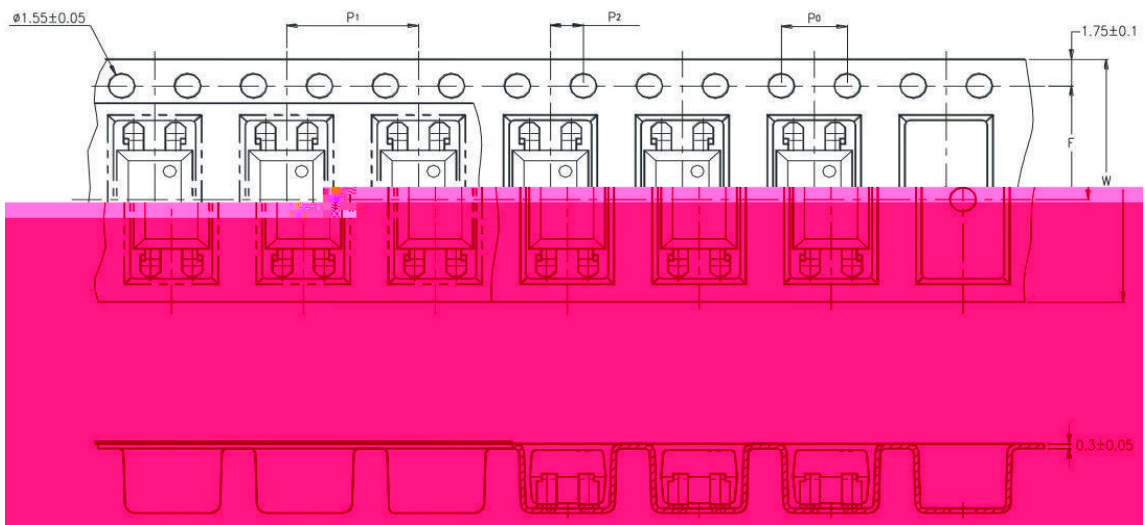
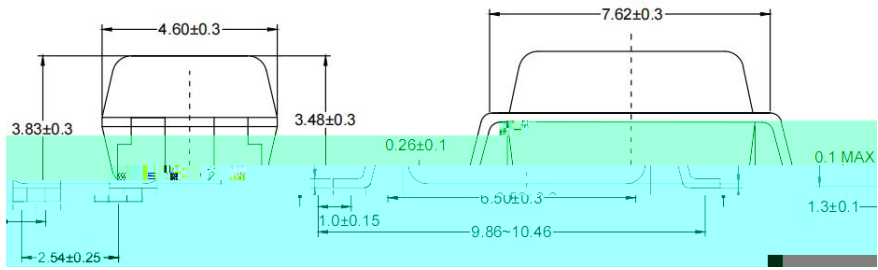
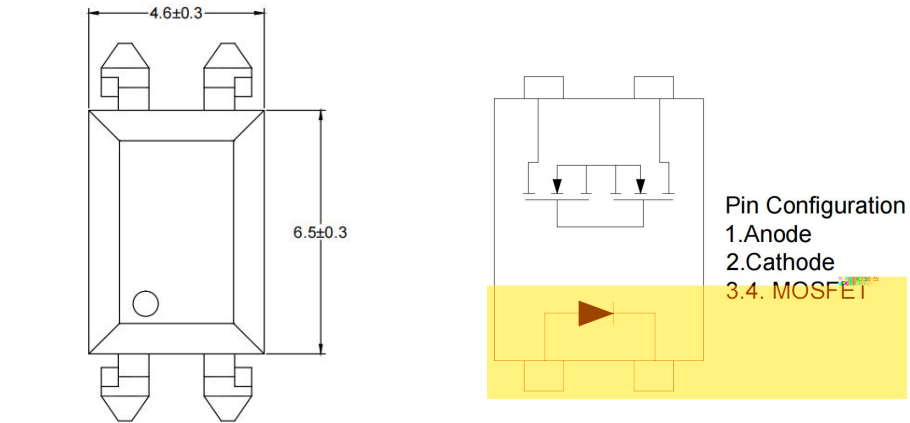





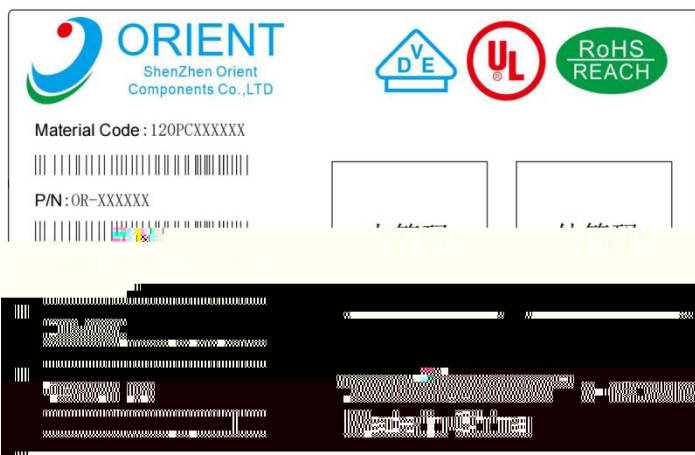

:)

Packing Information	
Packing type	Tube
Qty per Tube	100pcs
Small box (Inner) Dimension	525*128*60mm
Large box (Outer) Dimension	545*290*335mm
The Amount per Inner Box	5,000pcs
The Amount per Outer Box	50,000pcs

Packing Information	
Packing type	Reel type
Tape Width	16mm
Qty per Reel	2,000pcs
Small box (inner) Dimension	345*345*58.5mm
Large box (Outer) Dimension	620x360x360mm
Max qty per small box	4,000pcs
Max qty per large box	40,000pcs









Material Code : 120PCXXXXXX

P/N : OR-XXXXXX

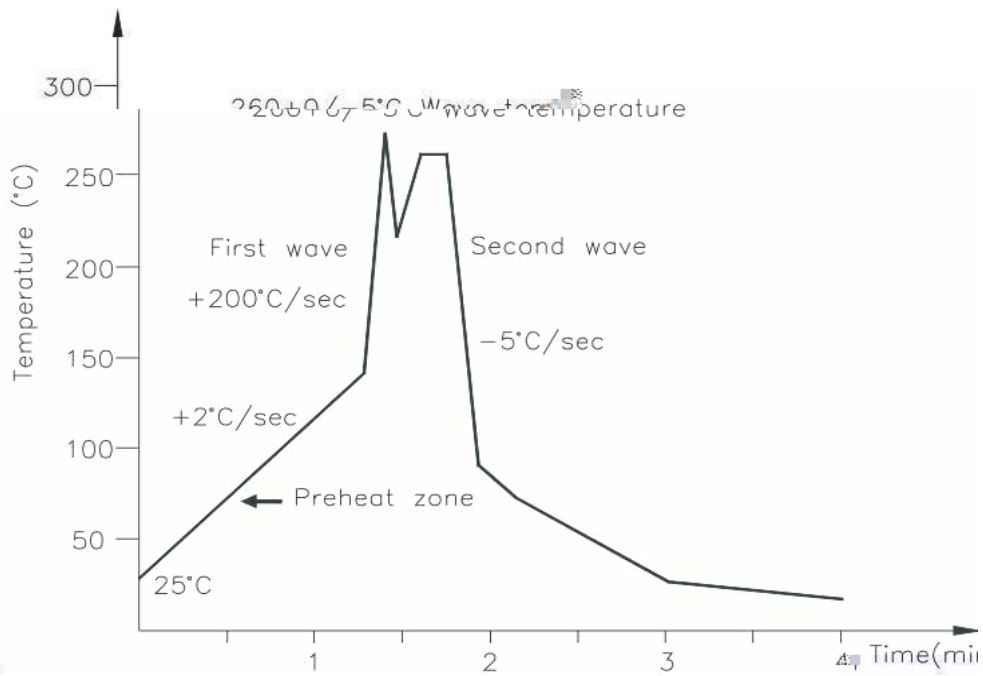
:





Temperature	380+0/-5 C
Time	3 sec max

Figure 1-1. Load current vs Ambient temperature

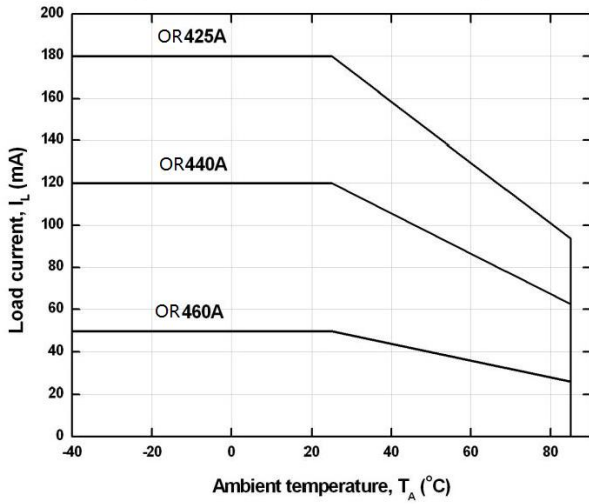

Figure 1-2. Load current vs Ambient temperature

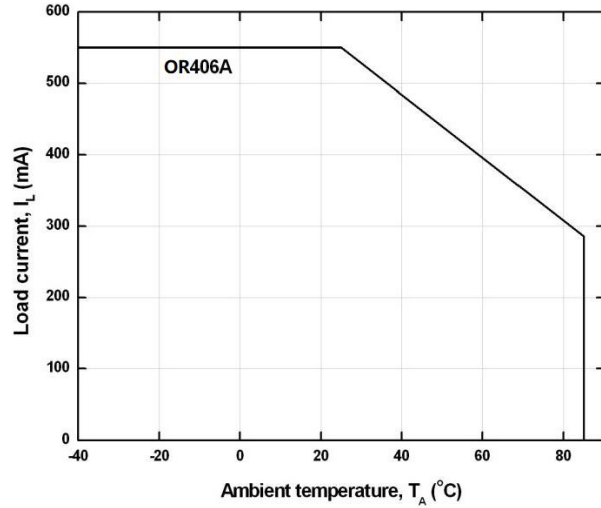

Figure 2-1. On Resistance vs Ambient Temperature

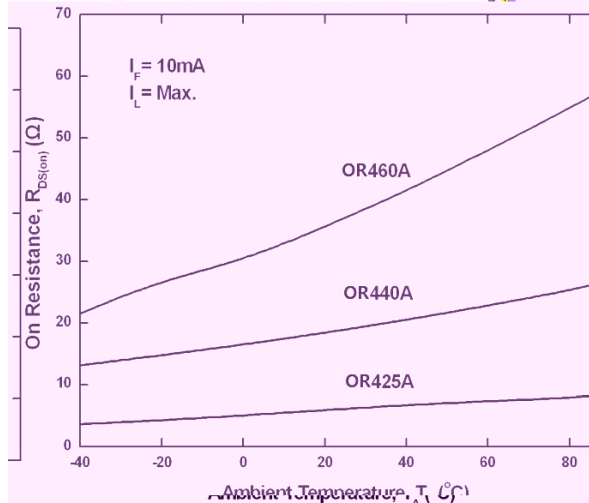

Figure 2-2. On Resistance vs Ambient Temperature

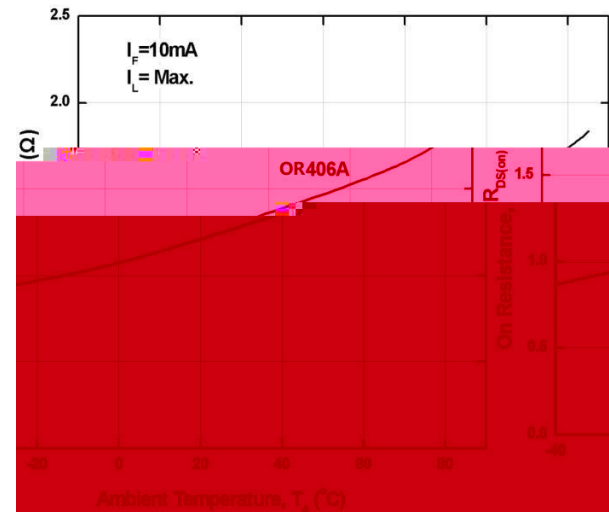

Figure 3. Switching Time vs Ambient Temperature

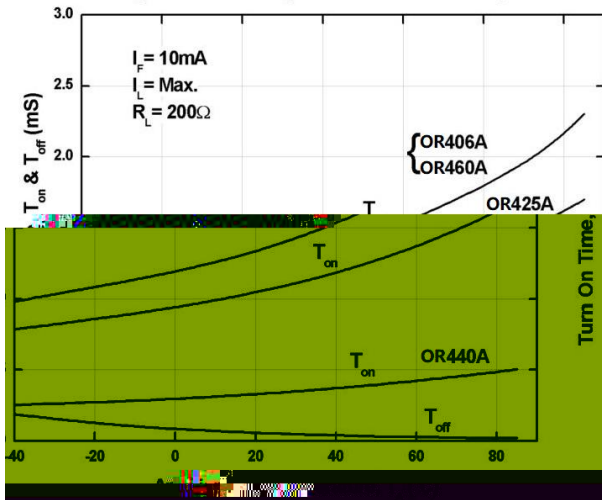

Figure 4-1. Turn On Time vs LED Forward Current

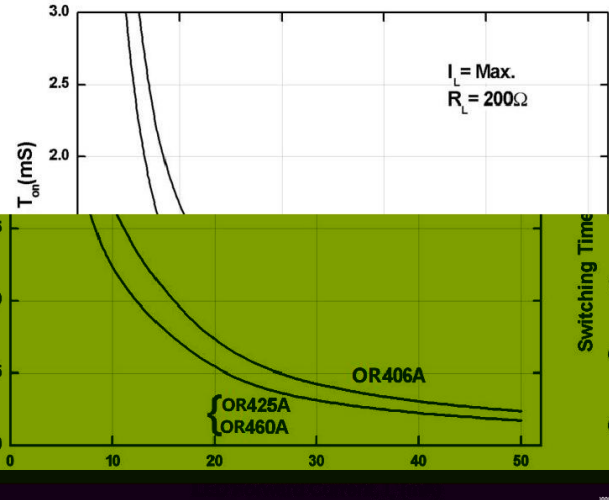

Figure 4-2. Turn On Time vs LED Forward Current

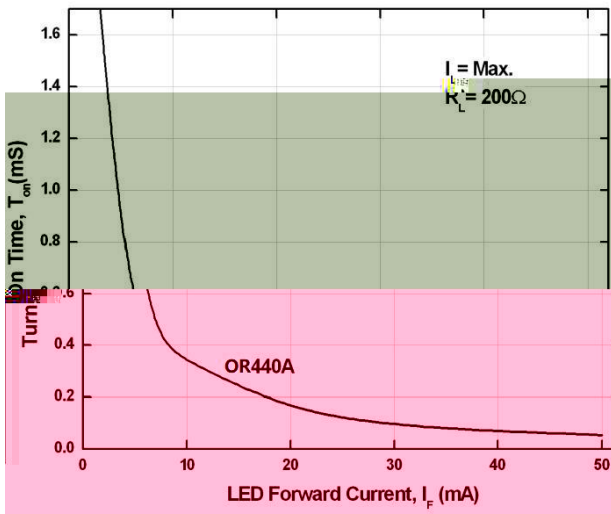

Figure 5. Turn Off Time vs LED Forward Current

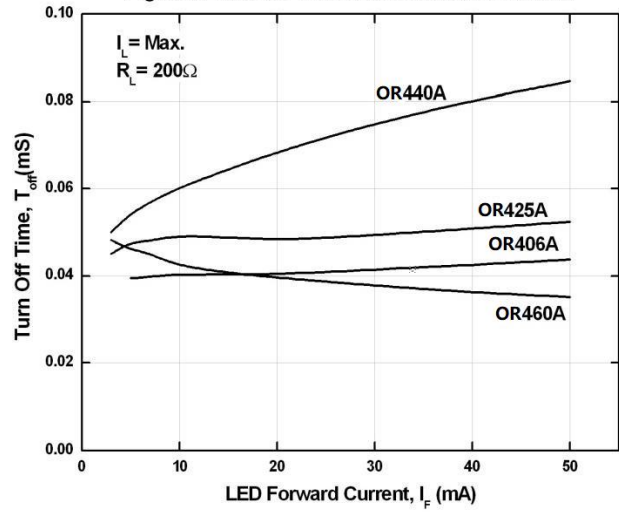

Figure 6. Normalized LED Operate on Current

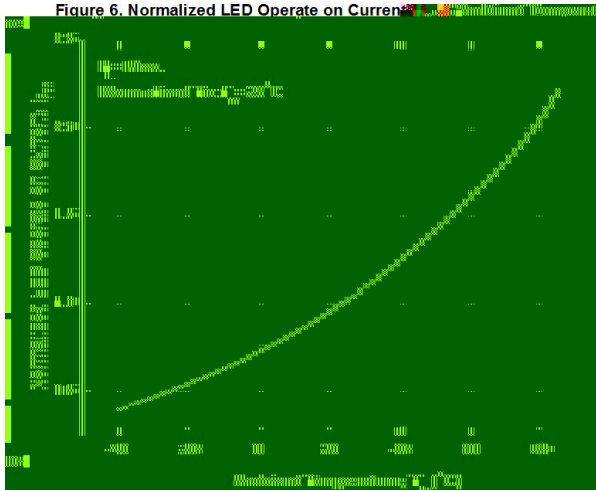

Figure 7. Normalized LED Turn off Current vs Ambient Temperature

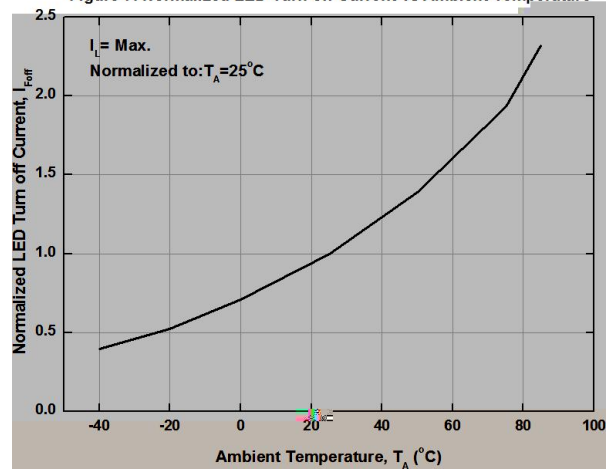

Figure 8. LED Dropout Voltage vs Ambient Temperature

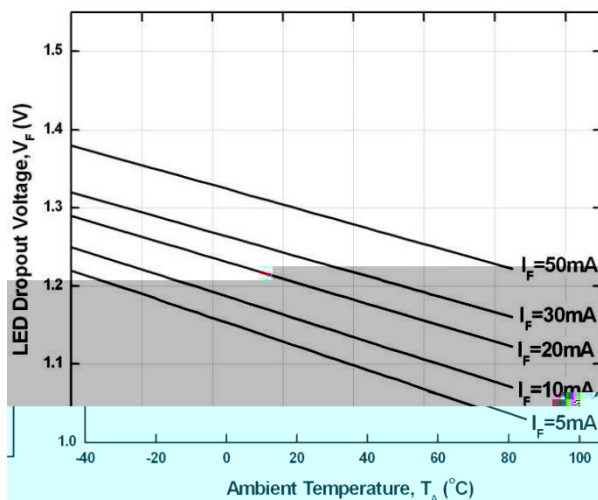

Figure 9-1. Load Voltage vs Load Current

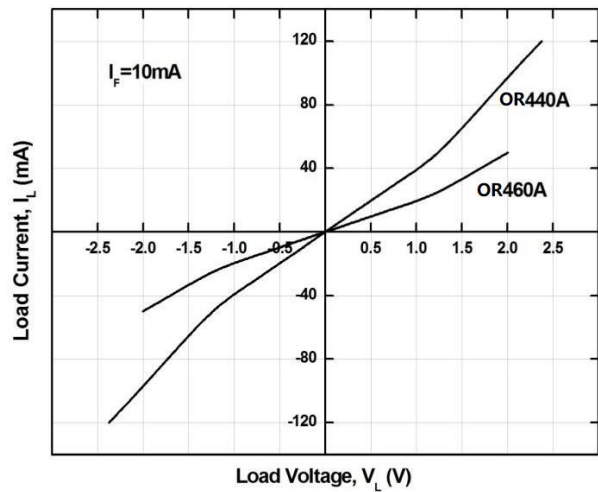

Figure 9-2. Load Voltage vs Load Current

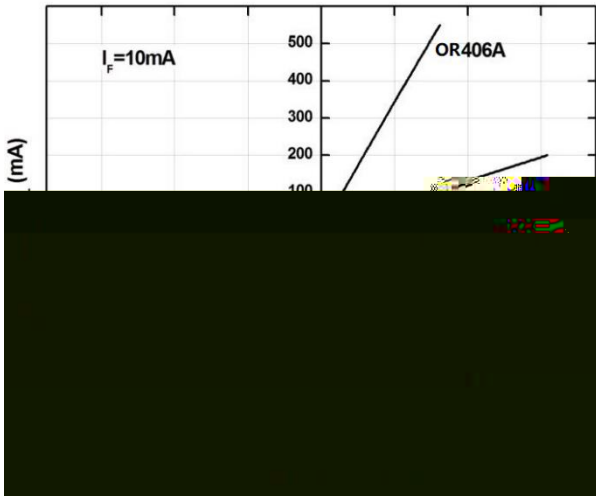

Figure 10. Off State Leakage Current vs Load Voltage

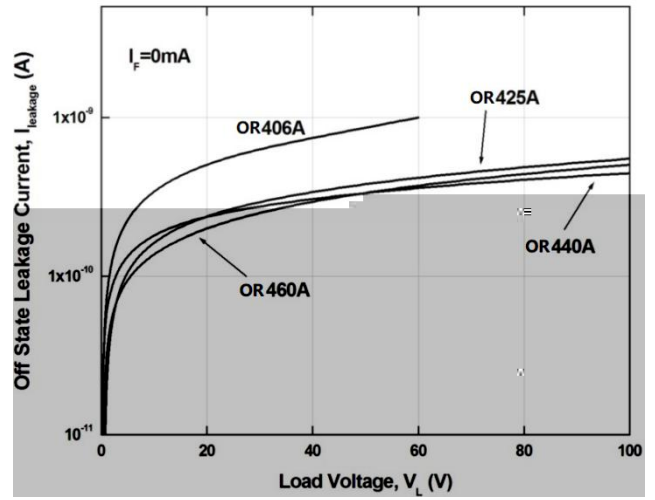

Figure 11. Applied Voltage VS Output Capacitance

