



# 深圳市弗瑞鑫电子有限公司

## 规格承认书

—  
——  
——

prepare	
check	
approve	



TRX电容一级代理商

深圳市弗瑞鑫电子有限公司

Add:深圳市宝安区西乡大道302号金源商务大厦B座3楼

Tel:0755-29563634

Fax:0755-27447020

**SMD- 2**

**SMD 2 . .**

**/N**

**/D**

**/E**

**/P**

	<b>SMD- 2</b> <b>SMD 2 . .</b>		
	/N		/D
	/E		/P

 <b>TRX</b> 专注电容器廿年	<b>SMD- 2</b> <b>SMD 2 . .</b>		
	/N		/D
	/E		/P

1. /P N

T   B   2   102   M   E  
 ① ②   ③   ④   ⑤   ⑥

①

	<b>SMD- 2</b> <b>SMD 2 . .</b>		
	/N		/D
	/E		/P

3. /D



 <b>TRX</b> 专注电容器廿年	<b>SMD- 2</b> <b>SMD 2 . .</b>		
	/N		/D
	/E		/P

4. /C

5. /P

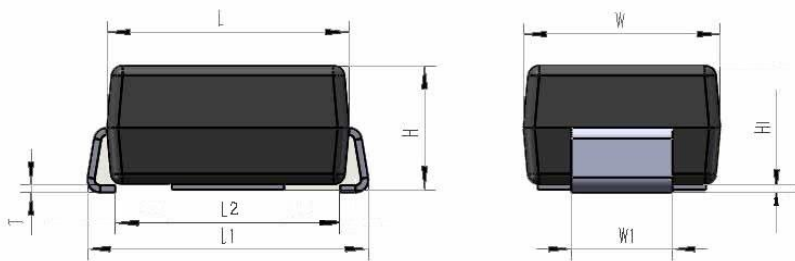

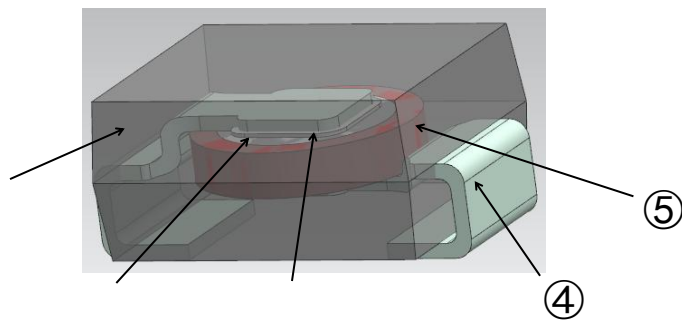
①		
②		
③		
④		
⑤		

**SMD- 2**  
**SMD 2 . .**

**/N**

**/D**

**/E**

 <b>TRX</b> 专注电容器廿年	<b>SMD- 2</b> <b>SMD 2 . .</b>		
	/N		/D
	/E		/P

/

°  
°C

°

°

°

/

**7. /P**



	<b>SMD- 2</b> <b>SMD 2 . .</b>		
	/N		/D
	/E		/P





SMD- 2  
SMD 2 . .

/N

/D

/E

/P

				±	
		±			
		±			
		±			
		±			

**SMD- 2**  
**SMDS**

SMD- 2  
SMD 2 . .





/N

/D

/E

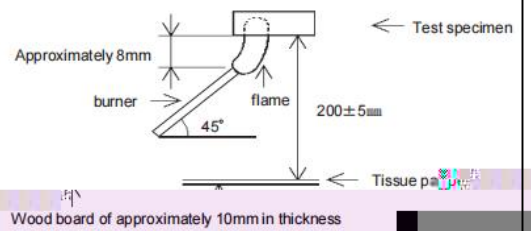
/P



 <b>TRX</b> 专注电容器廿年	<b>SMD- 2</b> <b>SMD 2 . .</b>		
	/N		/D
	/E		/P

			± ±
			± ±
			± ±
			± ±
			± ±

8. /C

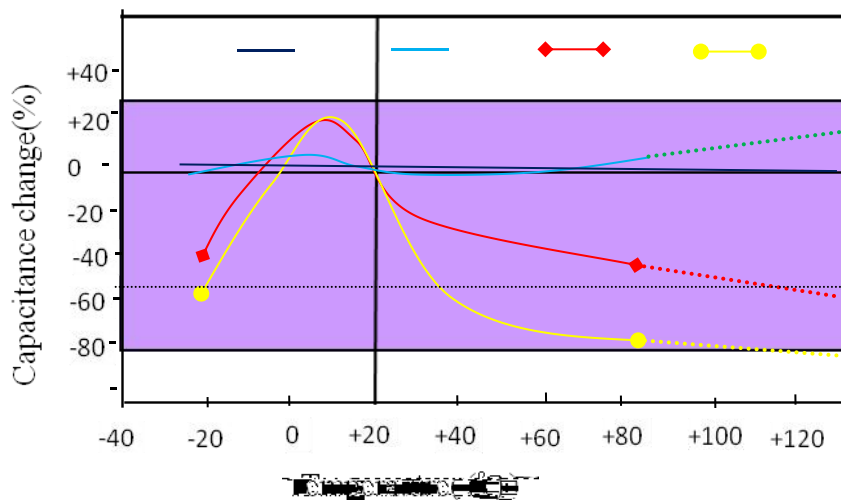



 <b>TRX</b> 专注电容器廿年	<b>SMD- 2</b>		
	<b>SMD 2 . .</b>		
	/N		/D
	/E		/P

11. /P P  
/

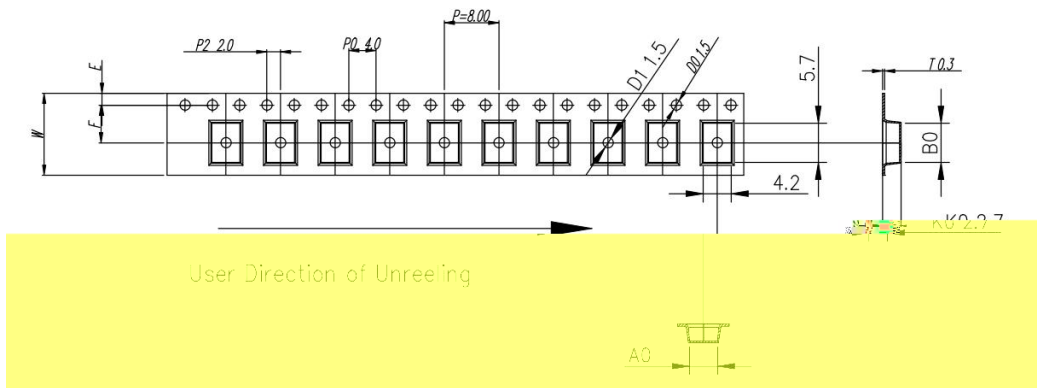

ITEM	W	A0	B0	K1	K0	P	F	E	D0	D1	P0	P2	T
DIM	12.0 ±0.30	4.2 ±0.10	5.70 ±0.10	--	2.70 ±0.10	8.00 ±0.10	5.50 ±0.10	1.75 ±0.10	1.5 ±0.00	1.5 ±0.10	4.0 ±0.10	2.0 ±0.10	0.30 ±0.05
ALTERNATE													

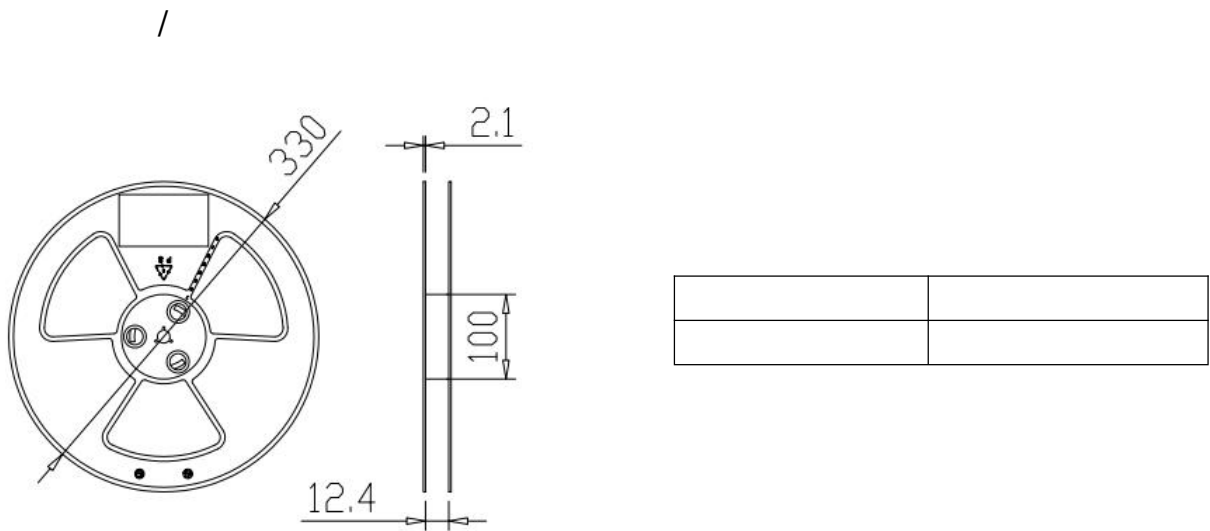

/

Item	Data	Remark
Cover tape adhesion	10 ~ 100g	Carrier tape and cover tape open angle 165 ~ 180° F=300±5mm/minute

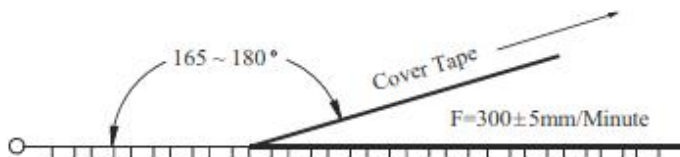

SMD- 2  
SMD 2 . .



/N

/D

/E

/P

/ -

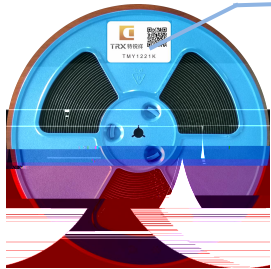

标签



料号

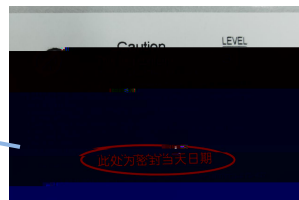

/O -

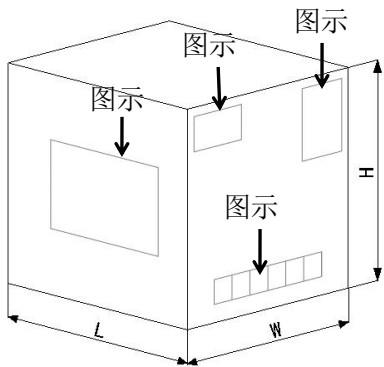

图示 /

图示 /

图示 /

/P

:



/



/



R



	<b>SMD- 2</b> <b>SMD 2 . .</b>		
	/N		/D
	/E		/P

12. /A

①

②