

\_\_\_\_\_

\_\_\_\_\_

\_\_\_\_\_

\_\_\_\_\_

			iiiiii iiii F



**TRX 特锐祥**  
专注电容器材料





SMD- 1  
SMD 1 . .

/N

/D

/E

/P

/

I



/

II

TR SMD- 1.CAP  
C R T.C D (U : F

T.C							

	<b>SMD- 1</b> <b>SMD 1 . .</b>		
	/N		/D
	/E		/P

 <b>TRX</b> 专注电容器廿年	SMD- 1		
	SMD 1 . .		
	/N		/D
	/E		/P

1. /P N

**T G \_1 102 K**

2. /P

	B
	Y1 102K 480V
	



 <b>TRX</b> 专注电容器廿年	<b>SMD- 1</b>		
	<b>SMD 1 . .</b>		
	/N		/D
/E		/P	

4. /C

5. /P

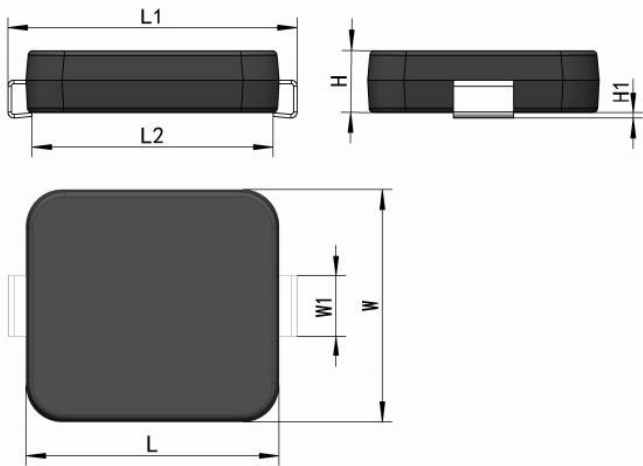

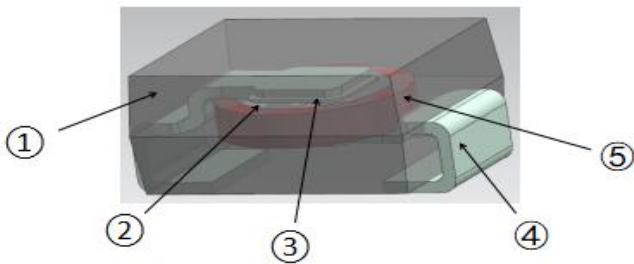





/N

SMD- 1  
SMD 1 . .



 <b>TRX</b> 专注电容器廿年	<b>SMD- 1</b>		
	<b>SMD 1 . .</b>		
	/N		/D
/E		/P	

/

/

7.            /P



 <b>TRX</b> 专注电容器廿年	<b>SMD- 1</b>			
	<b>SMD 1 . .</b>			
	/N		/D	
	/E		/P	



SMD- 1  
SMD 1 . .

/N

/D

/E

/P

/N

/D

/E

/P

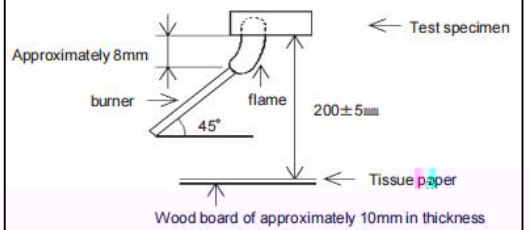

 <b>TRX</b> 专注电容器廿年	SMD- 1		
	SMD 1 . .		
	/N		/D
	/E		/P

8. /C

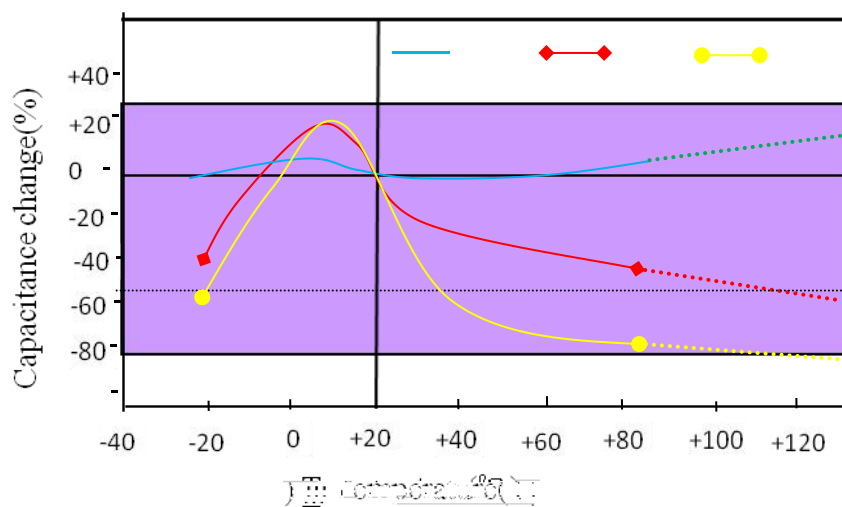

	SMD- 1		
	SMD 1 . .		
	/N		/D
	/E		/P

9.

/C

**R HS H.F.  
REACH**



10.

/S

/

/

11. /P

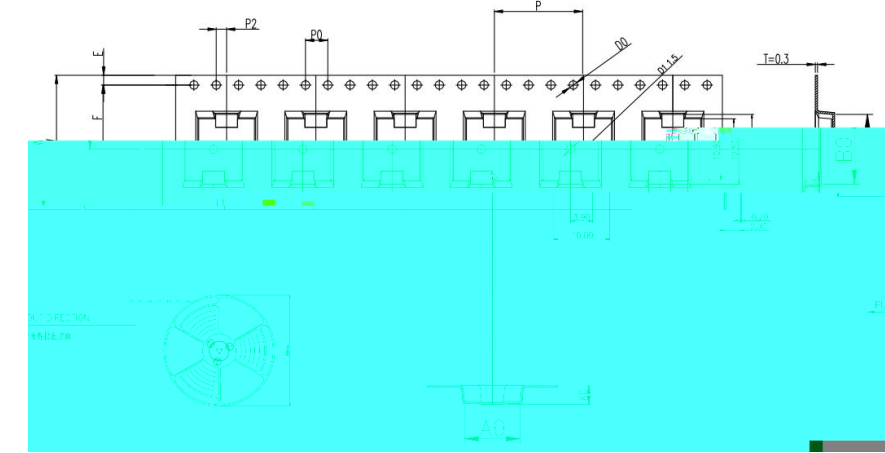

ITEM	W	A0	B0	K1	K0	P	F	E	D0	D1	P0	P2	T		
DIM	24.0	$^{+0.30}_{-0.30}$	$^{+0.10}_{-0.10}$	$^{+0.10}_{-0.10}$	$^{+0.10}_{-0.10}$	3.45	$^{+0.10}_{-0.10}$	16.0	$^{+0.10}_{-0.10}$	11.50	$^{+0.10}_{-0.10}$	1.75	$^{+0.10}_{-0.10}$	0.30	$^{+0.05}_{-0.05}$

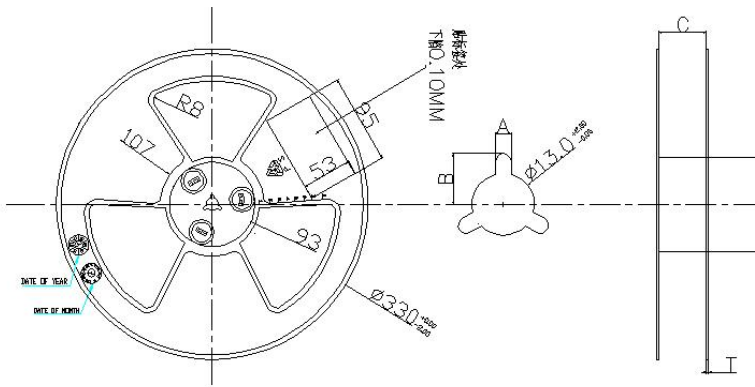

SPEC	A±0.3	B±0.5	C $^{+0.5}_{-0.0}$	D±0.5	T±0.2
24	2.3	10.75	24.4	Ø97	2.2

Item	Data	Remark
Cover tape adhesion	10 ~ 100g	Carrier tape and cover tape open angle 165 ~ 180° F=300± 5mm/minute

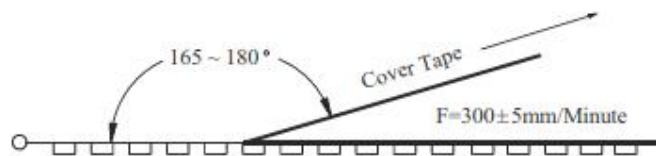



 <b>TRX</b> 专注电容器廿年	<b>SMD- 1</b>		
	<b>SMD 1 . .</b>		
	/N		/D
		/P	

/ -





TRX 特锐祥  
TGY1102K





TRX Des: TRX-SMD Y. CAP  
P/N: /  
QMfr: TGY1102K  
D/C: 2021.11.15  
LOT. NO: BSC2108015002  
QTY: 1000 PCS  
SPEC: SMD-Y1Y5P102K/AC400V





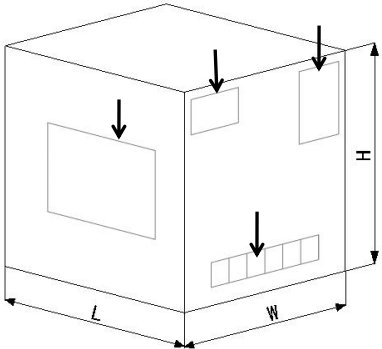

/O -







/

/

/

/P :







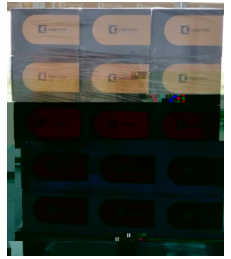

/

/

R

