

**Features:**

**Application:**

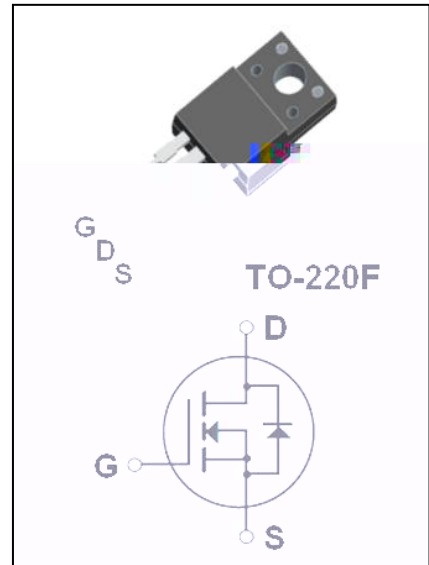

**Absolute Maximum Ratings**

		±	

\*

**Thermal Characteristics**



**Electrical Characteristics** ○

<b>Off Characteristics</b>						
△		○				○
△						
		○				
<b>On Characteristics</b>						
<b>Dynamic Characteristics</b>						
<b>Switching Characteristics</b>						
<b>Drain-Source Diode Characteristics and Maximum Ratings</b>						

、  
、  
、  
、  
、  
、

○ ○  
○

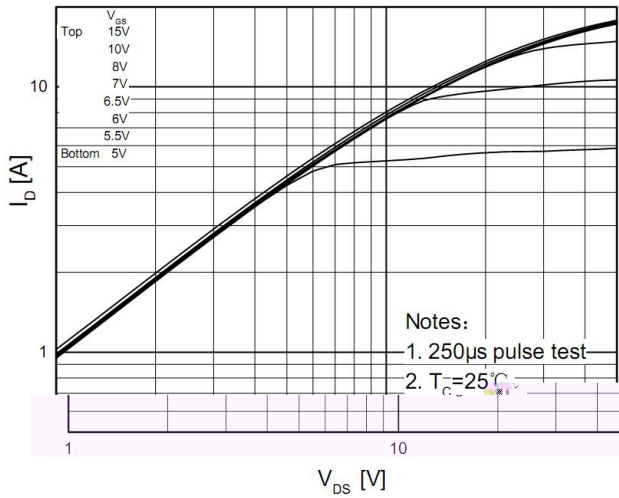
**On-Regin Characteristics**



**Transfer Characteristics**

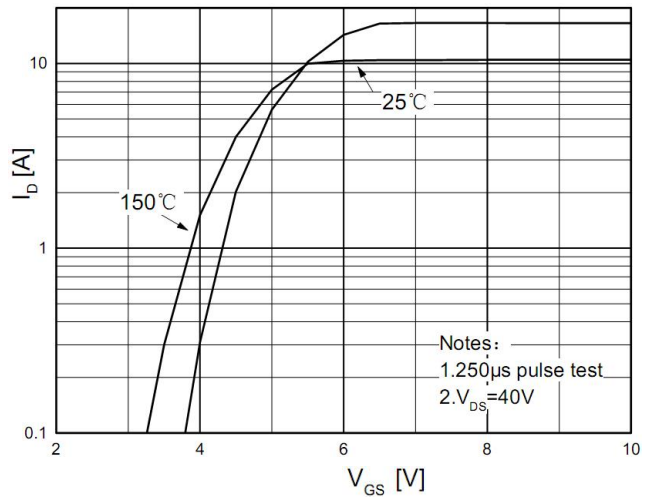

**On-Resistance Variation vs. Drain Current and Gate Voltage**

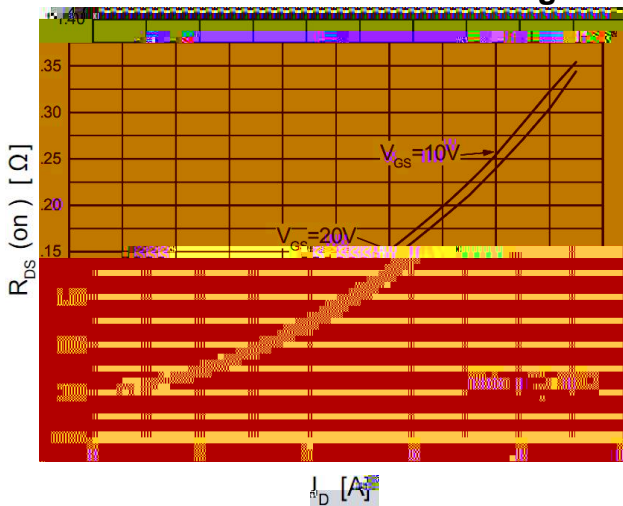

**Body Diode Forward Voltage Variation vs. Source Current and Temperature**

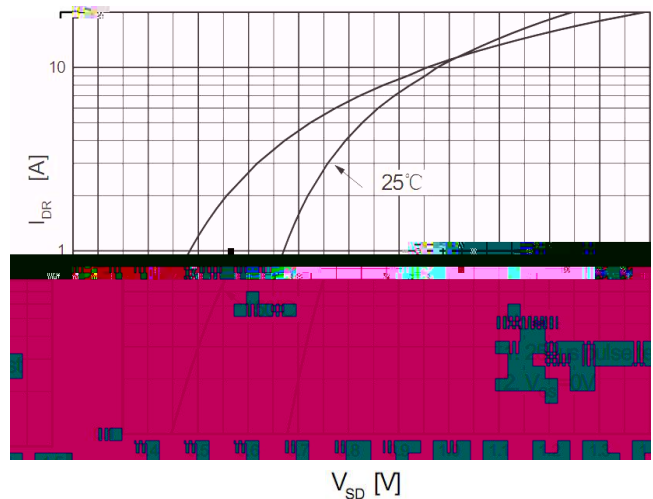

**Capacitance Characteristics**

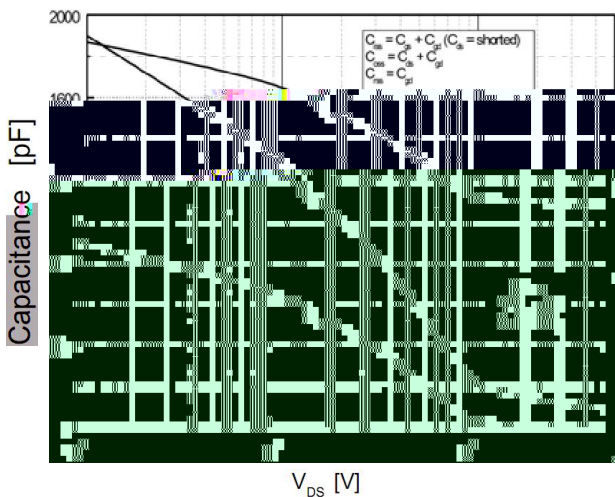

**Gate Charge Characteristics**

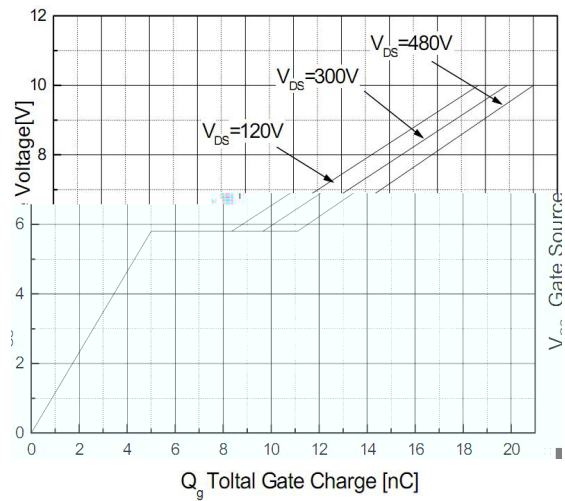

**Breakdown Voltage Variation vs. Temperature**

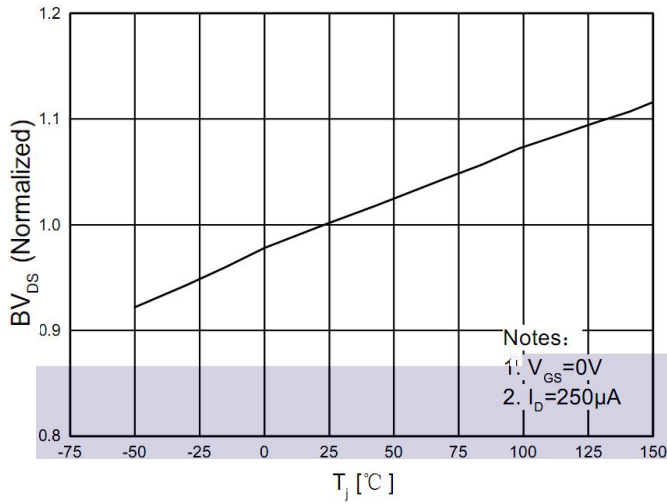

**On-Resistance Variation vs. Temperature**

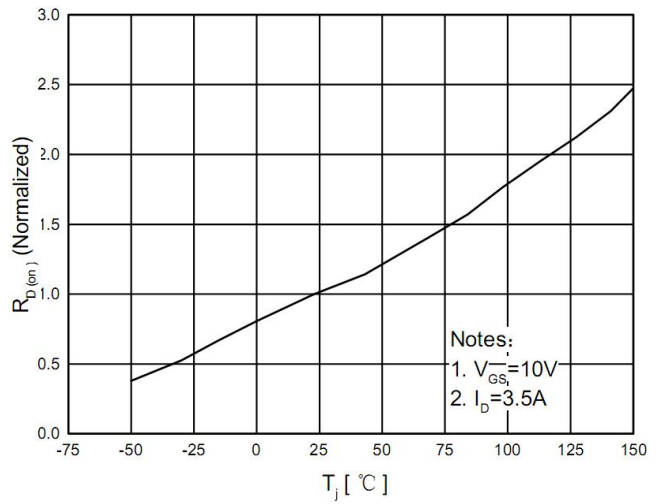

**Maximum Safe Operating Area**

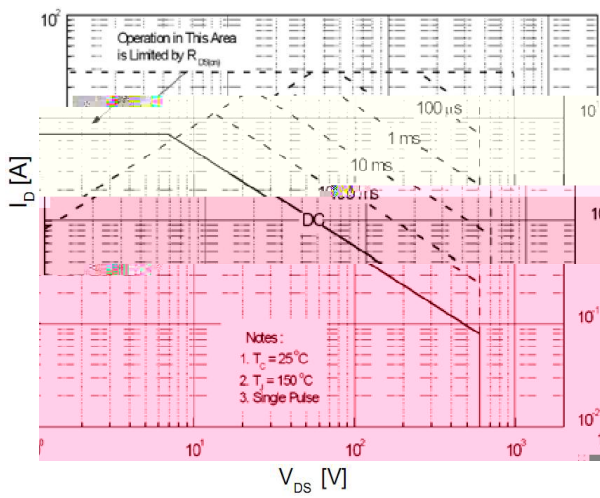

**Maximum Drain Current Vs. Case Temperature**

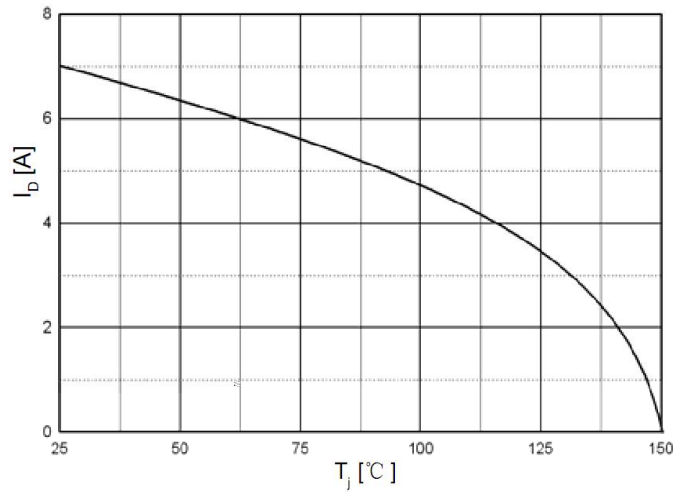

# TO-220F Package Dimensions

:

